

Dynamic DU892 DU893

OPERATION & SERVICE MANUAL

PORTABLE DENTAL UNIT

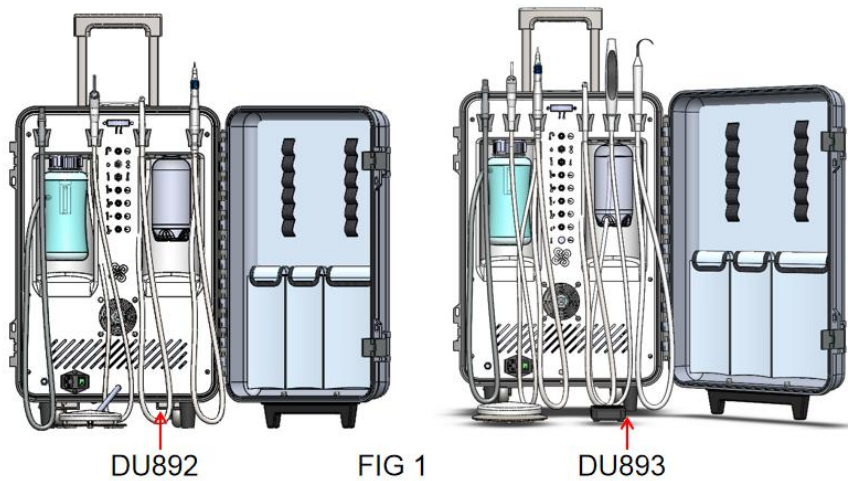

Note: Before operating or maintenance the unit, please read the manual carefully. This manual is just for guidance, and our company has the right to improve the design.

content

1. Brief introduction	3
1.1 Contents of the manual.....	3
1.2 Performance and structure.....	3
1.3 Intended use.....	3
1.4 Safety information.....	3
1.5 Periodic safety inspections	4
1.6 The requirements of external components.....	5
1.7 Salert NoticesAnd Symbols.....	5
2. Technical specifications	6
2.1 Power parameter.....	6
2.2 Performance and accessories.....	6
2.3 Product classification	7
2.4 Conditions of transportation, storage and application	7
2.5 Electromagnetic Compatibility.....	7
3. Product Structure and Installation	11
3.1.1 DU892 Structure.....	11
3.1.2 DU893 Structure.....	12
3.2 Installation procedure	12
3. Operation Functions	16
5: Operation:	18
6. Operation and Maintenance	19
7.Trouble-shooting	21
8. Air and water connection diagram of DU Series Portable Dental Units	23
8.1 DU892 air water working principle diagram.....	23
8.2 DU893 air water working principle diagram.....	23
9. DU series portable dental unit electric principle diagram	24
9.1 DU892 Electric Principle Diagram	24
9.2 DU893 electric principle diagram	24
10. Notices.....	25
11. DU series portable dental unit packing list.....	25

1. Brief introduction

Thank you for purchasing our DU portable dental units. It is our company's well-developed multi-purpose mechanical and electrical integration of energy-saving product with small, mobile, good appearance, less power consumption, free maintenance, safe and durable etc. It is mainly used for clinics and hospitals in the treatment of oral health. In order to be convenient for you to operate the unit, please read the manual carefully.

1.1 Contents of the manual

The operation manual includes brief introduction, installation and test, maintenance and so on. You can get help referring to the contents.

1.2 Performance and structure

DU portable dental units include 3-way syringe, handpiece, foot control, clean bottle, drain bottle, built-in oil-free air compressor, air tank, and drawbar.

1.3 Intended use

The DU series portable dental unit was designed to be used in dental clinics and hospitals, as one of the main units for dental Diagnosis, prevention, and surgical treatment.

1.4 Safety information

1.4.1 Electric safety

- To avoid the risk of electric shock, this equipment must only be connected to a supply mains with protective earth.

- Before connect the power plug, please ensure the power voltage consistent with the named voltage which this product required.

- To avoid unsteady voltage, please do not use the power socket together with other electric equipment.

- Before maintain or repair the product, please unplug that electric wire firstly.

- Please check the electric wire and plug regularly to avoid the damage or extrusions.

1.4.2 Cleaning

Please keep the environment around the product clean. Unplug that electric wire before cleaning the machine. The process of cleaning as follows: firstly wipe the outer surface with a soft cloth stained with neutral detergent, and then use a soft cloth to clean the machine again.

Warning: Do not use liquid or detergent containing flammable substances.

1.4.3 Other safety information

When using the product, please strictly operate the machine in according to the following rules:

1) Disinfection and sterilization

Before use, disinfection and sterilization are necessary to avoid the infection caused by bacterium and virus.

2) In treatment, it is necessary for the patient to breathe only by nose to avoid the risk of swallowing the cracked equipments.

3) The handpieces should be operated with distilled water simultaneously. If operate the handpieces without distilled water, the handpiece will overheat and cause damage to the teeth.

4) Only skilled staff through training can operate the equipment. Undue operation may cause severe injury.

5) This product cannot be used in flammable mixture environment.

6) This product cannot be used in anesthetic and air, oxygen, nitrogen mixture environment.

7) Don't put the equipment together with oxygen cylinder.

8) Please do not operate This product or replace the accessories when the following situations occur:

- Damage of the power plug
- Equipment cannot work normally
- Breakdown of the equipment
- Water inlet of the equipment
- Loud or shrill noise, overheating outlet air or foul smells during operation.

When above situations occur, please contact with the manufacturer or local agent. In order to be convenient for us to offer after sale service, please offer drawing of electrical circuit, air and water connection diagram, packing list and other useful information when necessary.

9) Please use original or qualified disinfectant.

10) Turn off the power when the operator left.

11) Dispose of waste liquid and waste solid according to the local health regulations.

12) Do not use and store the equipment outside the specified environment.

13) Keep accessories from dropping to avoid damages.

14) Keep the electric wire from loosening in the process of treatment.

15) Please use accessories from original manufacturer.

16) Keep the equipment in a solid and horizontal level.

1.5 Periodic safety inspections

The following projects should be inspected at least once a year by the trained and skilled person:

Check the equipment and the functional status of the machinery in the attachment.

Check whether the mark of the related safety is clean or not.

Check whether the blown fuse accords with the current rating fuse and the characteristic

Check whether the performance of the equipment accords with the description in the manual.

Testing whether the ground resistance is less than the required resistance described in the IEC60601-1: 0.1Ω.

Testing whether the earth leakage current is less than the required resistance described in the IEC60601-1: normal Condition: 500uA, single fault condition 1000μA.

Testing whether the touch leakage current is less than the required electric current described in the IEC60601-1: normal Condition: 100uA, single fault condition: 500 μA.

Testing whether the patient current leakage is less than the required electric current described in the IEC60601-1: for the alternating current: 0.5mA, for the continuous current: 10μA.

Testing whether the patient leakage current is less than the required current described in the IEC60601-1 in the single fault condition: for the alternating current: 0.5mA, for the continuous

current: 50uA.

Testing whether the auxiliary leakage current is less than required current described in the IEC60601-1:

The alternating current in the normal condition: 0.10.5mA, for the continuous current 10µA;

The alternating current in the single fault condition: 0.5mA, for the continuous current is 50 µA.

Write down all the test data on the operational diary, if the above test is failed or the equipment cannot work normally, then you should maintain the equipment.

1.6 The requirements of external components





















1.6.1 All external parts must be certified by CE, and also you need to check technical parameters related to spare parts, sketch map, technical manuals and instructions, production qualification test report and other contents.





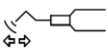

1.6.2 Check whether the parts will accord with the requirements of the company before Installation the parts.

1.6.3 The installation parts should be operated by the trained person.

1.7 Salert NoticesAnd Symbols

In the Installation, Operation and Maintenance Manual and on packaging and product, the following labels or symbols are used for important information:

	Fuse		Attention, see instructions for use
	Ground Protective	I	ON
	Serial Number	O	OFF
	Producing Date		Manufacturer
	Type B Equipment		EU Representative Information
	Saliva ejector with hand control-valve		Water
	On / Off switch		High-speed/Low-speed switch
	Coolant		Handpiece-Air
	Foot – operated		Foot switch
	Speed control		Ultrasonic scaler
	3-way Syringe		Spray cooling
	Handpiece		Scaler switch

	Fragile		This Side UP
	Keep Dry		Limited Stacking
	LED Curing Light		This symbol indicates that this product is not to be disposed with your residential or commercial waste.

2. Technical specifications

2.1 Power parameter

Figure 1

Model	Voltage/Frequency	Power	Rated current	Fuse value	Inflatable time	Specification(W×D×H)	Net Weight
DU892	~110-127V 60 Hz	550VA	≤6.4A	F8AH 250V	≤35 S	450×310×680 mm	26kg
	~220-240V 50-60 Hz	550VA	≤3.2A	F5AH 250V	≤35 S	450×310×680 mm	26kg
	~230V 50Hz	550VA	≤3.2A	F5AH 250V	≤35 S	450×310×680 mm	26kg
DU893	~110-127V 60 Hz	550VA	≤6.4A	F8AH 250V	≤35 S	450×310×680 mm	28kg
	~220-240V 50-60 Hz	550VA	≤3.2A	F5AH 250V	≤35 S	450×310×680 mm	28kg
	~230V 50Hz	550VA	≤3.2A	F5AH 250V	≤35 S	450×310×680 mm	28kg

2.2 Performance and accessories

No.	Model	Performance and Accessories										
		Tank	Motor	Unit	H.S. Handpiece connector		L.S. Handpiece connector	Instrument tray	3-way Syringe	Saliva Ejector	LED Curing Light	Scaler
					1pc	2pcs						
1.	DU 892	•	•	•	•		•		•	•		
2.	DU 893	•	•	•	•		•		•	•	•	•

Note: "•" Basic Accessory, "○" Optional Accessory

Figure 2



Warning: Please operate the unit strictly under the named supply voltage, because the unsteady current can cause injuries to the unit.

Please install power voltage regulator when supply voltage is unsteady, and the rated power is no less than 1000VA.

2.2.1 Air supply parameter

The air supplied by the built-in compressor is clean and dry (Air pressure: 4-6.5bar, air flow: >50L / min). If the compressed air is wet, press the drain valve to drain off the water in tank timely.

2.2.2 Water supply parameter

The water offered for the handpiece and other parts is directly from clean water bottle; please refill the bottle with distilled water timely.

2.3 Product classification

2.3.1 Classification of electric shock protection: Type I equipment.

2.3.2 Classification of electric shock guarding: Type B equipment.

2.3.3 Classification of waterproof: Normal equipment.

2.4 Conditions of transportation, storage and application

2.4.1 Transportation and storage

The machine should be transported and stored in following condition:

Temperature: -10°C+50°C

Range of relative humidity: ≤90 %

Range of atmospheric pressure: 50 kPa ~ 106 kPa

2.4.2 Working condition

Temperature: 5~40°C

Relative humidity: ≤80 %

Atmospheric pressure: 86kPa ~106kPa

The dental unit should not be used in the environment with a mixture of flammable anesthetic, oxygen and nitrogen.

2.4.3 Mode of operation: Intermittent Running

Mode of operation of the portable dental unit depends on the working system of its motor.

The motor's duty cycle is S3 30%.

The S3 is an intermittent cycle work system, means that Is run by a series of the same work cycle, each cycle includes a constant load operation time, and a broken can halt time, the starting current of each cycle does not significantly influence on temperature rise is 30% duty cycle, namely load duration and the percentage of the ratio of the whole cycle time.

2.5 Electromagnetic Compatibility

The machine pass the electromagnetic compatibility test of IEC60601-1-2, should you have any questions, please contact our service department, thank you!

Electromagnetic Emission Standards and Our Announcement		
DU series dental unit should be used in following electromagnetic environment, and the use of this product should ensure to use under suitable environment.		
Electromagnetic Emission Test	Standards	Electromagnetic Environment Standards
Radiation Electromagnetic Disturbance	CISPR 11 I FORM A CLASS	Electromagnetic emission of DU series dental unit can only satisfy its inherent functions, so its wireless radiation level is so low, that could not effect the contiguous electronic equipment.
Power Disturbance Voltage	CISPR 11 I FORM A CLASS	

Harmonic Emission	IEC 61000-3-2	DU series dental unit can used by all companies and institutes, and could not connect with household or public low voltage power system.
Voltage Fluctuation/Flash	IEC 61000-3-3	

Electromagnetic Emission Standards and Our Announcement			
DU series dental unit should be used in following electromagnetic environment, and the use of this product should ensure to use under suitable environment.			
Electromagnetic Emission Test	IEC 60601 TEST VALUE	Standards	Electromagnetic Environment Standards
Electrostatic Discharge (ESD) IEC 61000-4-2	±6 kV Touch ±8 kV Air	±6 kV Touch ±8 kV Air	The materials of floor should be wood, concrete and ceramic tile. If the floor is synthetic material, relative humidity no less than 30% .
EFT IEC 61000-4-4	±2kV Power Supply Line	±2kV Power Supply Line	The quality of power supply is used in special commerce or hospital.
Surge (Impact) IEC 61000-4-5	±1 kV Line to Line Mode ±2 kV Line to Earth Mode	±1 kV Line to Line Mode ±2 kV Line to Earth Mode	The quality of power supply is used in special commerce or hospital.
Voltage Sag And Short Supply Interruption Voltage Change IEC 61000-4-11	<5% UT (>95% dip in UT) for 0.5 cycle 40% UT (60% dip in UT) for 5 cycles 70% UT (30% dip in UT) for 25 cycles <5% UT (>95% dip in UT) for 5 sec	<5% UT (>95% dip in UT) for 0.5 cycle 40% UT (60% dip in UT) for 5 cycles 70% UT (30% dip in UT) for 25 cycles <5% UT (>95% dip in UT) for 5 sec	The quality of power supply is used in special commerce or hospital. When DU series portable dental units need to continuous operation when grid interrupts, please use uninterruptable power output.
Power Frequency Magnetic	3A/m	3A/m	/

Fields	IEC 61000-4-8		
Note: UT is alternating voltage before testing.			

Electromagnetic Emission Standards and Our Announcement			
DU series dental unit should be used in following electromagnetic environment, and the use of this product should ensure to use under suitable environment.			
Protection Test	IEC 60601 TEST VALUE	Standards	Electromagnetic Environment Standards
Radio transmission IEC 61000-4-6	3 Vrms 150 kHz to 80 MHz	3 Vrms 3 V/m	<p>Portable or mobile radio communication equipment should stay away from DU series portable dental unit, including cables, also should leave more than the recommended separation distance calculated.</p> <p>Recommended separation distance</p> $d = \left[\frac{3.5}{V_1} \right] \sqrt{P}$ $d = \left[\frac{3.5}{E_1} \right] \sqrt{P} \quad 80 \text{ MHz } 800 \text{ MHz}$ $d = \left[\frac{7}{E_1} \right] \sqrt{P} \quad 800 \text{ MHz } 2.5 \text{ GHz}$ <p>P: is the fixed output power by radio equipment manufacturer, the unit is W.</p> <p>D: Recommend separation distance. Fixed radio transmitter, determined by electromagnetic measurements, A: Each frequency band must be less than the standard requirements. B: The equipment maybe interfered nearby the device with following symbols:</p> 
Radio radiation IEC 61000-4-3	3 V/m 80 MHz to 2.5 GHz		
<p>Note: 1 Between 80 MHz and 800 MHz, higher frequency range applies.</p> <p>2 This specification maybe do not suitable for all situations, because the propagation of electromagnetic waves can be effected by the absorption and reflection of buildings, objects and people.</p> <p>A: The electromagnetic strength of fixed radio transmitter, such as radar station, cordless telephone and mobile radios, amateur radio, FM and AM radio and television, this can not be predicted in theory. The estimated of electromagnetic environment depends on the fixed radio transmitters, and electromagnetic measurement points should be considered. If the magnetic strength nearby the DU series is more than the above allowed value, then DU series portable dental unit should be observed to verify by the normal operation. In addition, when to re-install the DU series portable dental unit, the above information should you measured again.</p> <p>B: Frequencies above 150kHz to 80 MHz, the electromagnetic intensity should be less than 3V/m.</p>			

Recommended separation distance between DU series portable dental unit and Portable or mobile radio communication equipment
DU series portable dental unit for radio interference to be controlled electromagnetic environment, the users of DU

series portable dental unit should ensure the minimum distance between the DU portable dental unit and portable or mobile radio communication equipment according to the following recommended value, and take the maximum output power into account.

Communications equipment, the rated maximum output power(W)	Separate communication channels established in accordance with the distance (m)		
	150 kHz to 80MHz $d = \left[\frac{3.5}{V_1} \right] \sqrt{P}$	80 MHz to 800 MHz $d = \left[\frac{3.5}{E_1} \right] \sqrt{P}$	800 MHz to 2.5GHz $d = \left[\frac{7}{E_1} \right] \sqrt{P}$
0.01	0.117	0.117	0.233
0.1	0.369	0.369	0.738
1	1.167	1.167	2.333
10	3.689	3.689	7.379
100	11.667	11.667	23.333

Because the rated maximum output power of communications equipment do not mentioned above, the recommended separation distance d (meters) can be estimated according to same communication device. P is the maximum output power (in watts) according to the communications equipment manufacturers.

Note: 1. From 80 MHz to 800 MHz, separation distance is more accordance with the higher frequency.

2. This specification do not apply to all situations. Because the propagation of electromagnetic waves by buildings, objects, people effects of absorption and reflection.

3. Product Structure and Installation

3.1.1 DU892 Structure



1. Saliva Ejector	8. Air Adjustor for Low-speed Handpiece	15. Foot Control
2. housing	9. Water Adjustor for High-speed Handpiece	16. Handle
3. 3-way Syringe	10. Water Adjustor for Low-speed Handpiece	17. Pressure Gauge of Handpiece
4. Air Adjustor of Saliva Ejector	11. waste water Bottle	18. High Speed Handpiece
5. Air Switch of Clean Bottle	12. Fan	19. Low Speed Handpiece
6. High-speed/Low-speed Transferring Switch	13. Drain Valve	20. Clean Bottle
7. Air Adjustor for High-speed Handpiece	14. Power	21. Instrument Bag

3.1.2 DU893 Structu

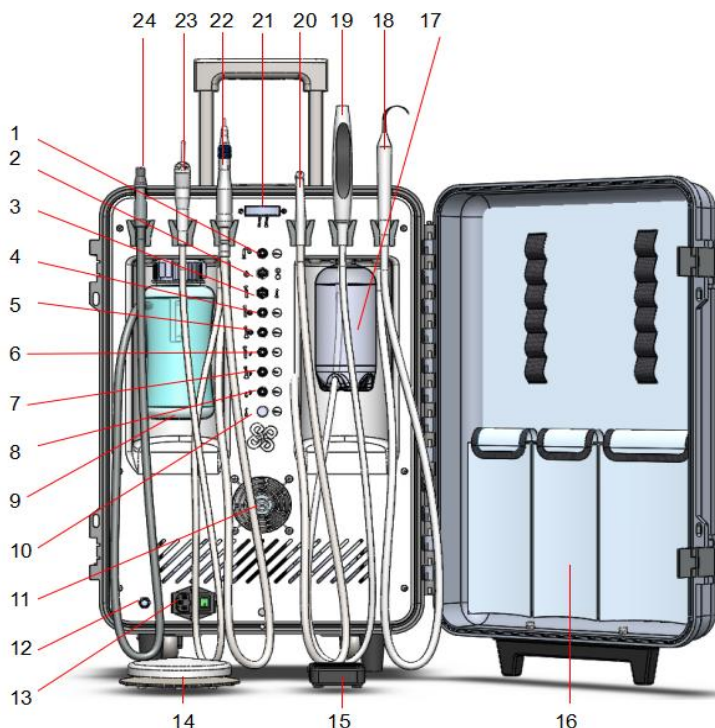

1. Air Adjustor of Saliva Ejector	9. waste water Bottle	17.Clean Bottle
2. Air Switch of Clean Bottle	10.Scaler Power	18. Scaler
3.High-speed/Low-speed Transferring Switch	11. Fan	19.LED Curing Light
4. Air Adjustor for High-speed Handpiece	12. Drain Valve	20.High Speed Handpiece
5. Air Adjustor for Low-speed Handpiece	13. Power	21. Pressure Gauge of Handpiece
6. Water Adjustor for High-speed Handpiece	14.Foot Control	22. Low Speed Handpiece
7. Water Adjustor for Low-speed Handpiece	15. Foot Control of Scaler	23. 3-way Syringe
8. Scaler Coolant	16. Instrument Bag	24. Saliva Ejector

3.2 Installation procedure

3.2.1 Open-package Inspection

Open the package, and check whether the dental unit is in good condition, check complement of unit, spare parts and consumable parts according to contract list .according to the packing list. If you have any questions, please contact our distributor or our company directly.

3.2.2 Installation

Take out the device and put it on the flat, solid floor. To open the case, and take out the foot control and water bottle on the floor, then take out the high speed handpiece connector, low speed handpiece connector,3-way Syringe and other application parts , hang them separately on the corresponding Holder(refer to fig1)

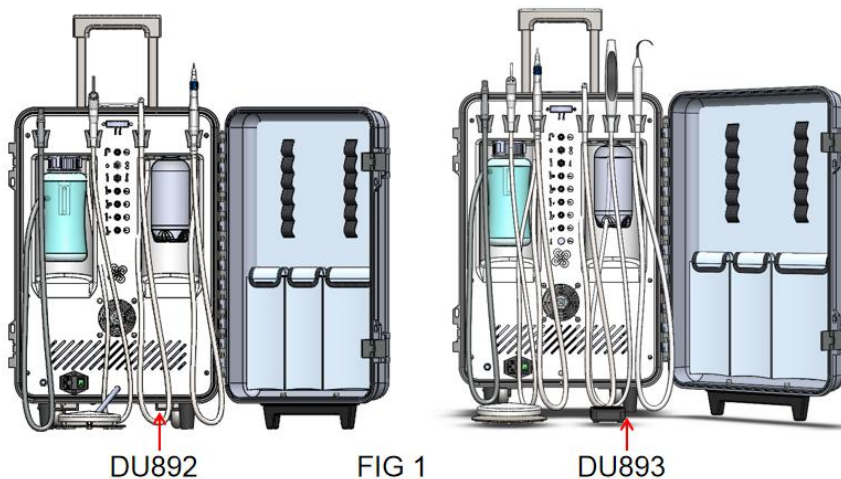

3.2.3 Handpiece

Our handpiece connector meets the standard ISO 9168, is the Type 3 (4-Line) /1(2-line) handpiece connector. Our standard configuration does not include the handpiece, and users should equip themselves with the handpiece that is suitable for our handpiece connector. The type 3 connector's structure of ISO 9168 shown in figure 2 and figure 3.

The type 1 connector's structure of ISO 9168 shown in figure 4 .

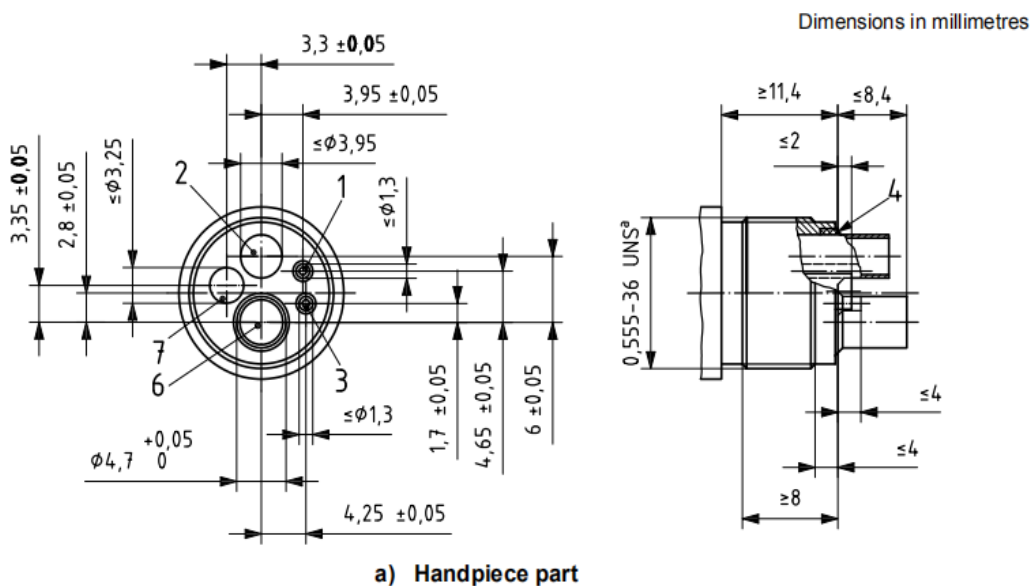

Figure 2 handpiece part of Type 3 connector

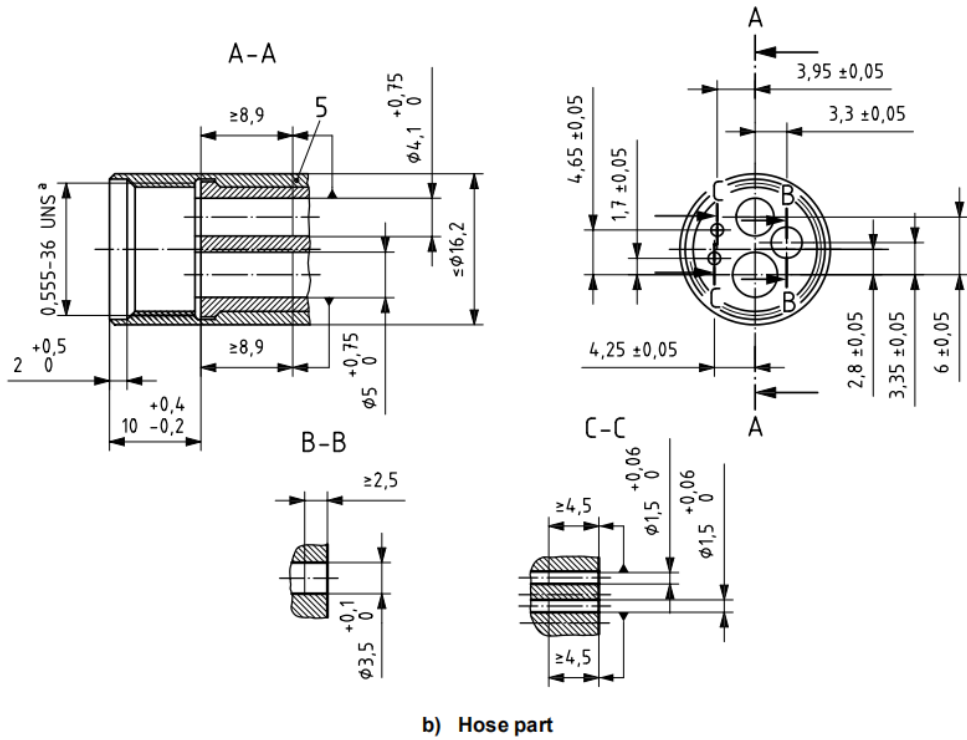

Figure 3 handpiece hose part of type 3 connector

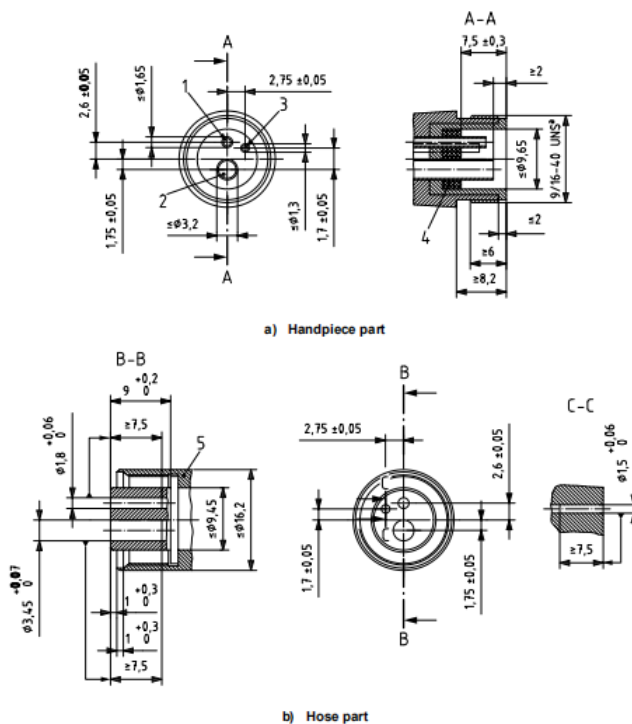

Figure 4: handpiece hose part of type 1 connector

Note: Attach a sterile handpiece to the (4-Line) handpiece connector and place the handpiece in Holder.



Warning: Do not run the handpiece without the pressure.

Statement: Only the handpiece which include anti-retraction function are to be used together with the dental unit.

3.2.4 Scaler (DU893)

The installation of scaler, please refer to its manual, use the torque wrench for scaler head and turn the head of scaler tighten, Otherwise it will not work. When you need to screw off the head of the scaler, you also need to use this torque wrench, as shown in figure 5.

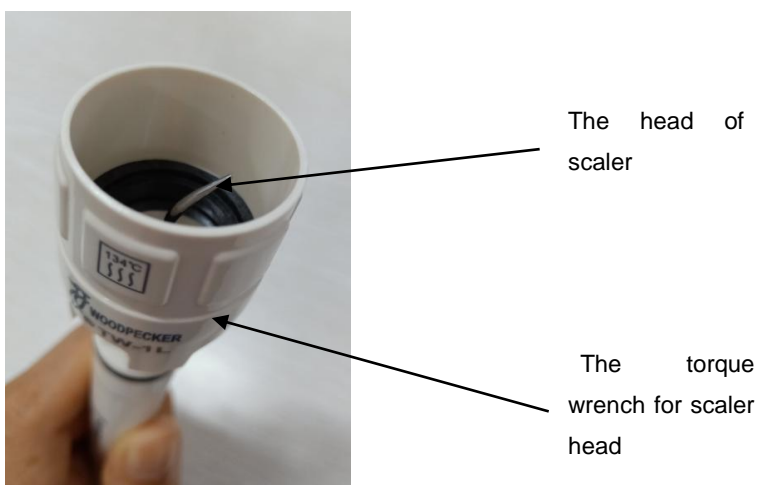

Figure5 the torque wrench for scaler head



Warning: There must be water of scaler, of will harm the patient and affect the life of scaler.

3.2.5 LED curing light (DU893)

The installation of LED curing light:As shown in figure 6, the optical tip is first inserted into the light curing machine, and then the filter plate is installed in the position shown in the figure. Please refer to its manual for detailed steps and note case.

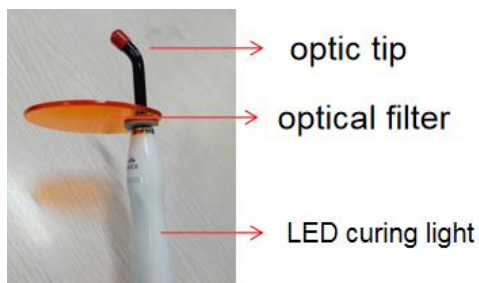

Figure 6 Installation diagram of LED curing light

3.2.6 3-way Syringe

The unit is equipped with a 3-way syringe, which use the distilled water together with handpieces. The inlet water tube and inlet air tube are connected to connector of the back panel. Press down (refer to Figure 7) the ring nut and insert the nozzle, and then lock the nozzle by resetting the ring nut.



Ring nut

Nozzle

Figure 7 Installation diagram of 3-way syringe

3.2.7 Saliva ejector

The unit is equipped with a saliva ejector, MHC provide 2 disposable suction tips for user. Please insert the disposable suction tip to the saliva ejector before use (refer to figure 8). The disposable suction tips after used should be handled according to local laws and regulations

Saliva ejector
switch

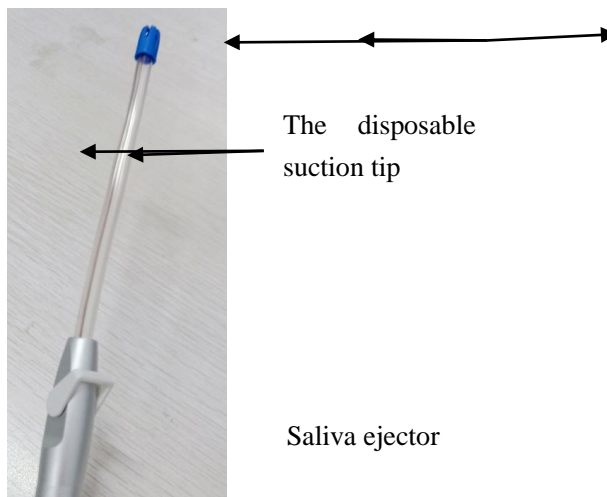

The disposable
suction tip

Saliva ejector

Figure 8 Saliva ejector tips

3.2.8 Power

Take out the power card from the instruments bag, connect the power card with the dental unit, and then connect the power plug with the power socket.

4: Operation Functions

1. Foot Control Controls:

The Foot control enables the operation of the handpiece, Saliva Ejector. .

2: Foot Control of Scaler controls

The Foot control of Scaler enables the operation of the **Scaler**.

3. Handpiece Controls:

- a.) Handpiece Off/On Toggle Switch - Turns Handpiece pneumatic drive pressure Off/On.
- b.) Off/On Coolant Toggle Switch - Turns Handpiece water coolant On/Off.
- c.) Air Control Switch - Allows adjustment of air pressure to the Handpiece.
- d.) Coolant Control Switch - Allows adjustment of water coolant to the Handpiece.

 **Note:** This time, the "Pressure gauge of handpiece" in the panel is the working pressure of handpiece, when using the handpiece, please do not exceed the max pressure of handpiece, and avoiding the harm of handpiece. To adjust the handpiece carefully, the turbine of handpiece is the precision devices, please read the manual before using carefully.

3. Three-Way Air/water Syringe:

- Pressing the left button dispenses water.
- Pressing the right button dispenses air.
- Pressing both buttons simultaneously dispenses an air/water mist.

4. Water Supply Bottle:

The unit incorporates a self contained pressurized water system. This system consists of a 1-liter white bottle, which dispenses water through the handpiece and 3-Way Air/Water Syringe. located in the upper right corner of the case.

For this unit, all water for handpieces, 3-way syringe and Ultrasonic Scaler are from the clean water bottle. Thus, the user needs to add the distilled water to the clean water bottle timely.

The methods of adding water is following:

1. Turn off the air switch, when the air in the bottle is drained off, holding the bottle by your hand, rotate clockwise and take down the bottle.
2. After injecting the water, counterclockwise rotate the bottle and make it tight (note to seal).
3. Then turn on the air switch, the process of adding water is finished.

In general, any of the following conditions having, you need to clean the bottle and change water in it.

- 1) The unit is not used by more than three days.
- 2) After using every day, you need to clean it.
- 3) The color of the water in the bottle is changed. (Not colorless transparent water)

5: Saliva ejector

The unit is equipped with a saliva ejector. Open the switch, use adjustor to adjust the suction flow, it could work normally.

 **Note:**

1. The unit could only use alone, it could not use together with handpieces at the same time. If not, it would affect normal use of handpieces.
2. Suck a cup of purified water, eliminate the seepers in the tube and clean the saliva bottle each day after use.

3. When cleaning, screw it off in an anticlockwise direction then use the disinfectant to clean it. Then screw it on the counterclockwise. (Note to tighten)

4. When the sewage collection bottle exceeds the highest water mark in the logo, please clean the sewage in time, and then loaded on to continue using.

5. Saliva Ejector function requires exhaust, when using the salivary function, please connect the bacterial filter to the bacterial filter installation connector(bacterial filter is optional); If device has bacterial filter, when the negative pressure gets lower obviously or no negative pressure, please check the bacterial filter, if there is any contaminant or moisture blocking, please replace it before use.

5 Ultrasonic Scaler (DU893)

The unit is equipped with an ultrasonic scaler. Pick up the ultrasonic scaler from the shelf; tread down the foot control, then it could be used normally. The power output could be adjusted. The adjustor is equipped on the face panel.

The head of the ultrasonic scaler must be screwed tighten. If not, there would have no efficient power output. The parts are rigid, please read the operation manual carefully.



Note: The ultrasonic scaler only could work with water supply, or that would damage the ultrasonic scale.

6 :LED curing light (DU893)

The unit is equipped with LED curing light. From the accessories, you may find the operation manual of curing light in its box, please read its operation manual for detailed operation steps.

5: Operation:

1. Connect the power cord to the unit and plug into appropriate power source.

IMPORTANT: Ensure that the Voltage

2: Turn the operation handle of power switch to “1” (fig 4) the unit will start immediately pressurize.(See Fig. 10).

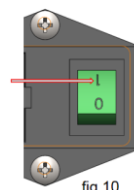

fig 10

3: Depress the Foot control: system components(Handpiece,Saliva Ejector) will activate.

4: Pick off the handpiece from rack, and please turn

the “Low speed /high speed transferring switch” to the “high speed handpiece”, press the foot control, turn the “Pressure Adjustor of High Speed Handpiece” counterclockwise, to adjust the handpiece to spray water from small to large. The turbine of handpiece start to spring water: namely that the handpiece begin to work. (see fig 9)

5: Pick off the handpiece from rack, and please turn the “Low speed /high speed transferring switch” to the “low speed handpiece”, press the foot control, turn the “Pressure Adjustor of Low Speed Handpiece” counterclockwise, to adjust the handpiece to spray

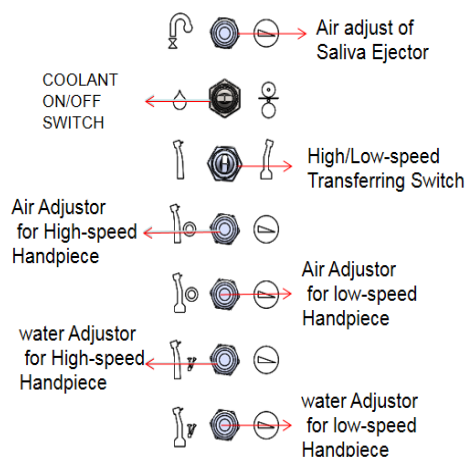

fig 9

water from small to large. The turbine of handpiece

start to spring water: namely that the handpiece begin to work. (see fig 9)

6. Use the 3-Way Air/Water Syringe as necessary for irrigation or drying.

7. Pick off the Saliva ejector from rack, Open the Saliva ejector switch, (see fig 7) use adjustor to adjust the suction flow, it could work normally.

8: Pick off the LED curing light from rack, it could work normally.

9: Pick off the Scaler from rack, press the foot control of Scaler , adjust the Scaler coolant and Scaler power, it could work normally.

(see fig 11)

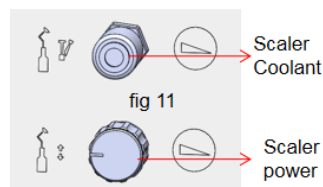

6. Operation and Maintenance

6.1 Because of its simple design, the DU series dental unit requires very little maintenance. Any maintenance that is needed can be performed in minutes.

6.2 Bleeding the system

If the unit will not be used for an extended period of time, or the unit might be subjected to freezing conditions, you should bleed the system. Simply empty the contents of the water bottle and install the bottle back into the cap. Operate the 3-way syringe and handpiece with water coolant 'ON' until just air comes through the water line. Pack unit and store as normal.

6.3 Handpiece flush

6.3.1 Flush the handpiece for about 5 seconds after every patient, and about 20 seconds at the beginning of each day.

6.3.2 Before using handpieces, the user need to roll and spray by 1 to 2 second to get rid of the dirt in tube, then prevent the occurrence of cross-infection.

6.4 General cleaning

6.4.1 The external surfaces of the case should be cleaned using a soft cloth moistened with a mild detergent solution. Any external surfaces of the unit that are contacted during use should be wiped down with a soft cloth moistened with a disinfectant at the beginning of each day and between each patient use.

6.4.2 Wipe surface of the units, prevent harmful materials from corroding the units.

6.5 Cleaning and disinfecting water path

Disinfect the water path weekly. Prepare a 1:10 bleach solution (1 part household bleach to 10 parts water). Remove water reservoir and discard residual water. Replace empty water supply tank and air purge all water path. Fill clean water bottle with bleach solution. Run bleach solution through all path. Allow bleach solution to stand in path for 10 minutes. Remove water supply tank and discard bleach. Flush water supply tank and all path thoroughly with clean water. Air purge and leave path dry until next clinical use.

6.6 Cleaning and disinfecting 3-way syringe tips

The DU series dental unit features a 3-way syringe with quick-change autoclavable tips. To remove a tip, press on the locking collar surrounding the tip socket and pull the used tip straight out of the socket (see Fig. 8). To insert a new tip, press locking collar and push tip into socket as

far as it will go. Release collar and gently tug on tip before using to ensure that tip is securely locked into socket.

Syringe Tip Sterilization:

- 1) Remove contaminated syringe tip.
- 2) Remove all visible signs of contamination before autoclaving.
- 3) Autoclave tip at 132° C (270° F) for ten minutes.
- 4) Sterilize between each patient use.

NOTE: Since only the tips can be autoclaved, it is recommended that the Air/Water Syringe be bagged with a disposable, single-use plastic sleeve between each patient use.(refer to figure 6 the 3-way syringe)

6.7 Cleaning the waste water bottle

After using waste water bottle, suck a cup of purified water, to clean the tube, suction generator and other spare parts to protect them from congestion and damage.

The suction tip is disposable, the abandoned suction tip shall be disposed according to the local laws and regulations of the user.

6.8 Cleaning and disinfecting handpiece

6.8.1 By using handpieces, you need to strictly comply with the operation and maintenance of the handpieces.



Note: the cleaning and lubrication of handpieces.

6.8.2 Please turn off the water switch, power switch and air switch when leave after treatment.

6.8.3. After using handpieces and before sterilization, the user needs to make the cleaning and lubrication, to make the handpieces work normally and prolong the use time. By using handpieces, you need to strictly comply with the operation and maintenance.

6.8.4 The following requirements are completely according to the provisions of the handpieces instruction manual.

- Remove the handpieces
- Get rid of all visible dirt.
- Make sterilizing in the saturated steam of 132°C by 10 minutes
- After treatment by each patient, please make them sterilizing before treatment for next patient.



Note: For the parts which couldn't tear down, please use disposable plastic package to sphere when using.

6.9. Cleaning and Disinfecting ultrasonic scaler

The following requirements are completely according to the provisions of the ultrasonic scaler instruction manual.

- before sterilization, please clean the ultrasonic scaler and the tip.
- Sterilization condition: 135°C in 10 minutes or 120°C in 20 minutes
- Use the soft cloth with 45% cleaner to clean the ultrasonic scaler. Do not make it into any liquid or directly spray any liquid. Or the liquid would enter into ultrasonic scaler to make it cutting-out and damage.

6.10. The handpieces tube and connections of ultrasonic scaler could only be cleaned by cleaner instead of temperature sterilizing.

6.11 Cleaning and Disinfecting of LED Curing Light

Please refer to the instruction manual of LED Curing Light for detail.

6.12 Change the fuse tube

6.12.1 Pull out the plug from the socket; pull out the fuse cover from the fuse socket.

6.12.2 Take out the damaged fuse tube

6.12.3 Insert the new fuse tube by make the fuse rating consistent with fusing feature in instruction manual.

6.12.4 Press the fuse cover in the fuse socket.



Note: The fuse tube unqualified could cause fires!

7.Trouble-shooting

Item	Problem	Reason	Check	Tips
1	The handpiece can not spray water while rotating.	The water in water tank has been used up.	Check the water volume of the water tank.	Add the distiller water.
		Air & water distributing valve is blocked.	Check the "Air switch" is open or not, or is working or not.	Open the "Air switch", or replace it.
		The double air switch can not work	Check the 3-way syringe sprays water or not.	Regulate the Air & water distributing valve or clean the valve core and o-ring.
Check the air pipe is good or not, or check the core can work or not.				
2	The handpiece leaks water when not in operation.	Air & water distributing valve fails to function.	Remove one side of the valves in handpiece, take out faucet, spring and valve core.	replace the valve core and o-ring
			Check there is any dirty, and o-ring can work or not.	
3	The air switch leak water or air	The core is circled too far.	Open the adjustor valve and to check it.	Install the core correctly.
		The core and o-ring is broken.	Open the adjustor valve and to check it.	Replace the o-ring

		The connector of valve is too loose	Check the connector leak the water or air or not.	Turn the connector tighten.
4	The 3-way syringe leads water and air	The button of 3-way syringe is not restored, or there is dirty, or the core and o-ring can not work well.	Check the water button of the 3-way syringe.	Clean or replace the core and o-ring.
5	The noise or shaking is so big, unit can not work.	The voltage is too low.	Let the professional person check the voltage.	Use the voltage stabilizer.
6	The built-in compressor can not be started up	The wire to the power supply has fallen off.	Check the connector of power is good or not.	Connect the line correctly.
7	The built-in air compressor keeps working and can not be stopped	Power line orelectronic component is loose. The solenoid of compressor can not work normally.	Open the panel, and to check the connector line and component When the compressor work, the solenoid valve can not close completely.	Let the professional person connect the line according to circuit diagram Open the core of
		The pressure switch is broken.	Check the pressure switch works normally or not.	Adjust or replace the pressure switch.
		The connector leaks air.	Reserve or listen the air flow, or use the bubble to check the connector of leakage air.	Connect the various connector correctly, avoiding leaking air.
		Pressed drain valve leaks air.	Check the pressed drain valve leakage of air or not.	Avoid leaking air.
8	No water for scaler	Air switch was close	Check the air switch	Open the air switch
		No water in bottle	Check the water volume of the water tank.	Add more distiller water
		The water adjustor of scaler is closed	Check the water adjustor	With large water flow
		Solenoid vale of scaler was broken	Check the solenoid valve	Replace the Solenoid Valve

8. Air and water connection diagram of DU Series Portable Dental Units

8.1 DU892 air water working principle diagram

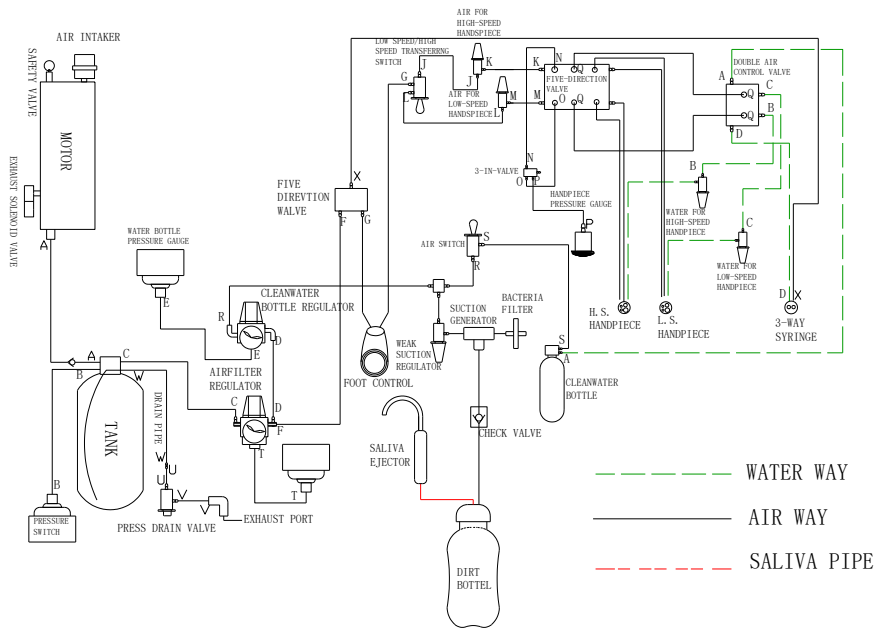

8.2 DU893 air water working principle diagram

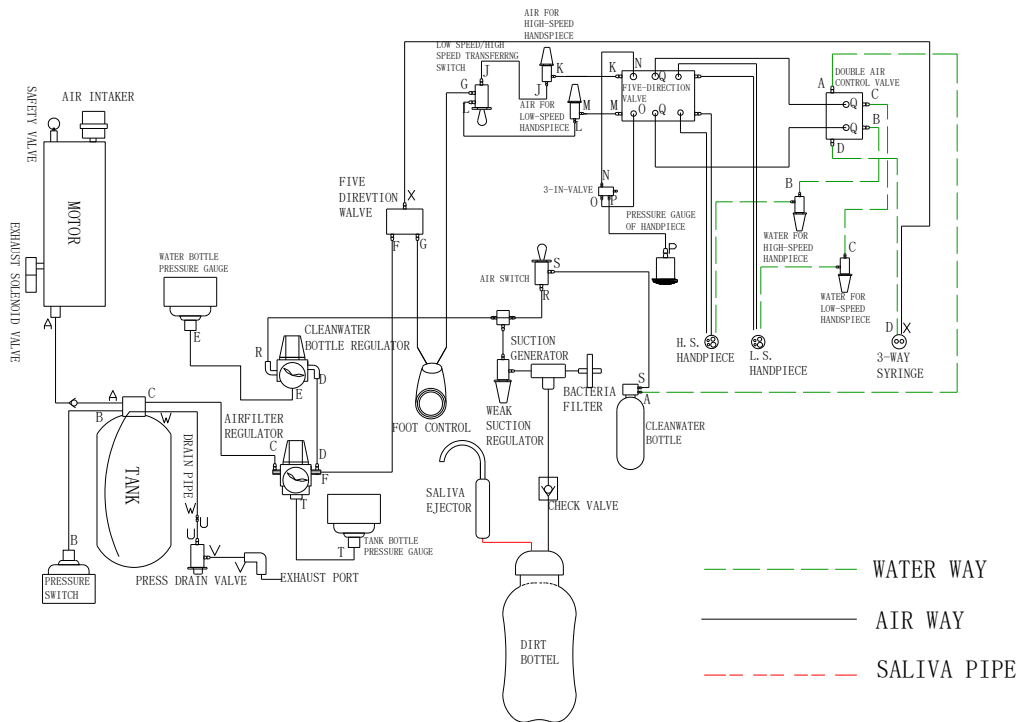

9. DU series portable dental unit electric principle diagram

9.1 DU892 Electric Principle Diagram

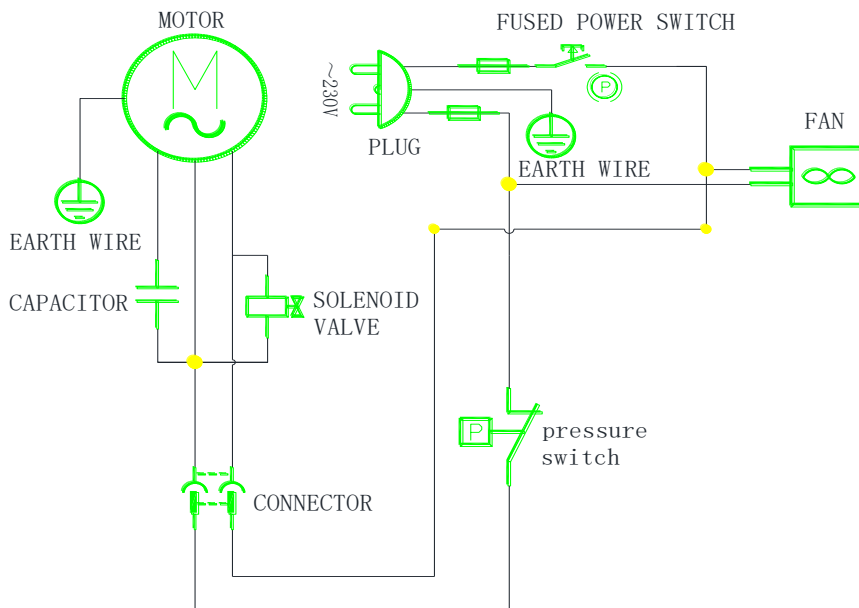

9.2 DU893 electric principle diagram

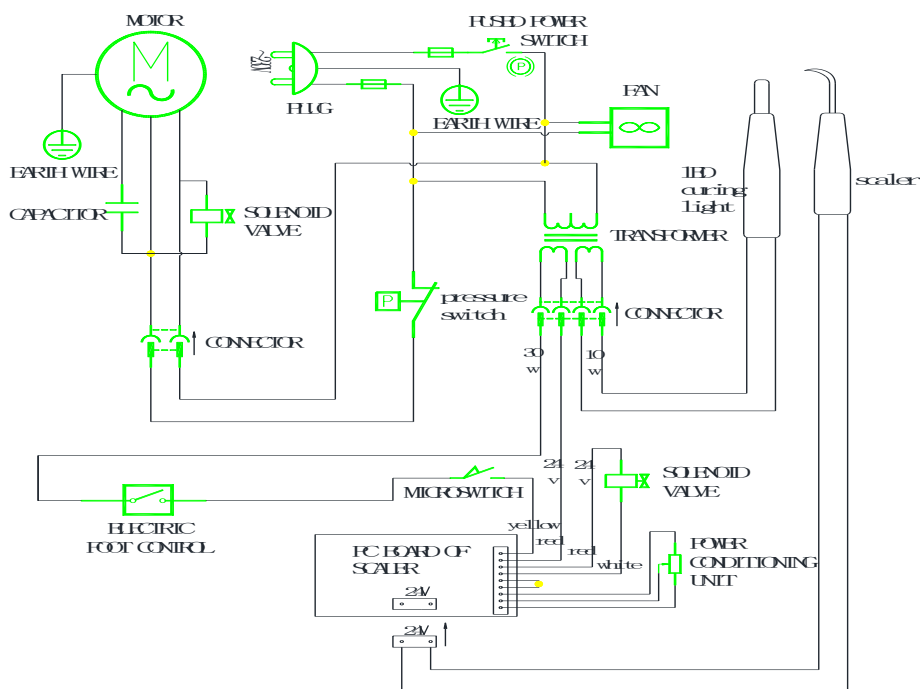

10. Notices

Storage

If the compressor will not be used for a prolonged time period, drain any condensate from the air tank. Then turn on the compressor for 10 minutes, keeping the drain valve open (1). Switch off the compressor by switch (3) at pressure switch (2), close the drain valve and disconnect the appliance from the mains.

Disposing of The Appliance

- Disconnect the appliance from the mains.
- Release air pressure in the pressure tank by opening the drain valve (1) (Fig.10).
- The components of the product are non-toxic.
- Dispose of the appliance following all environmental regulations.

Repair Service

Guaranteed and post-guarantee repairs must be done by the manufacturer, its authorized representative, or service personnel approved by the supplier. The manufacturer reserves the right to make changes to the appliance without notice. Any changes made will not affect the functional properties of the appliance.

Solving Problems

 **Caution!** Before proceeding, depressurize the air tank to zero and disconnect the appliance from the mains.

11. DU series portable dental unit packing list

Series No.	Product name	Quantity	Unit	Suitable for following models
1.	DU series body	1	pc	One of DU893、DU892
2.	Instruction	1	pc	One of DU893、DU892
3.	Accessory bag	1	pc	One of DU893、DU892
4.	Clean water bottle	1	pc	One of DU893、DU892
5.	Waste water bottle	1	pc	One of DU893、DU892
6.	POWER CORD	1	pc	One of DU893、DU892

Version information

Operation Manual No.DU-CE-B12

version number : (A/3)